



SNOW WOLF
INSTRUCTION

SW-025



**HOP
UP**

FOR AGES 18 YEARS AND UP

SW-025

SW-025 FOR AGES
18 YEARS AND UP
MADE IN CHINA



WARNING!

Only adults in or above 18 years old can purchase. Children under 18 years old should operate under the guardianship of parents or legal guardianship. Observe warnings and cautions written in your operating manual. OBEY all laws and regulations on proper airgun handling in your area.

Product assembly drawing

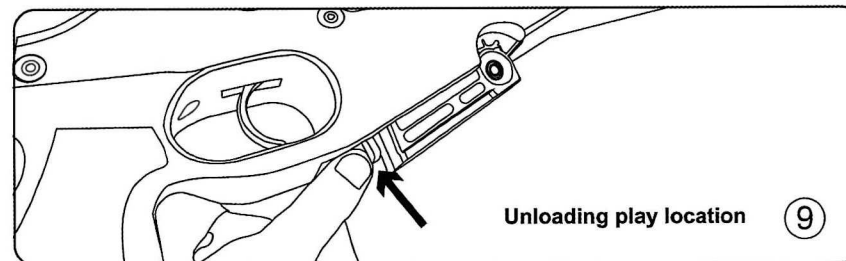
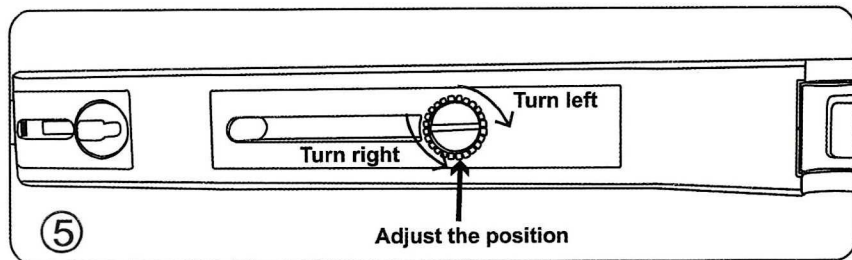
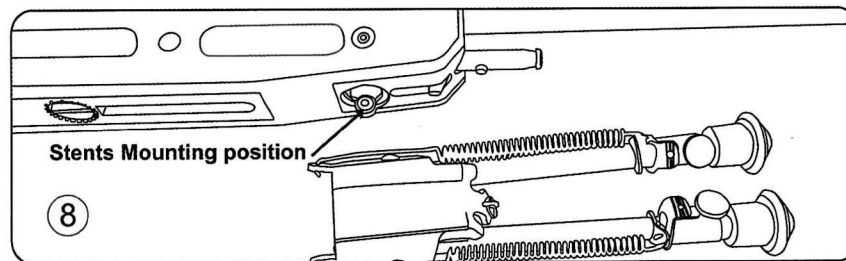
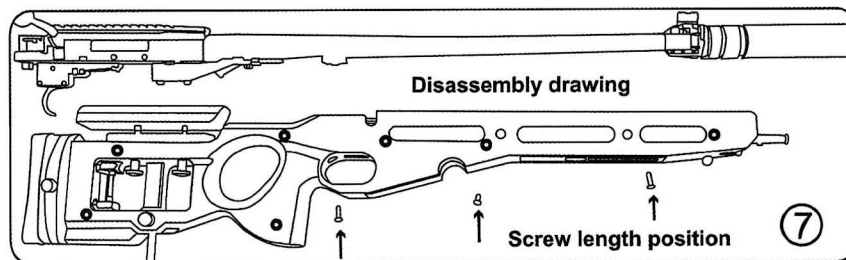
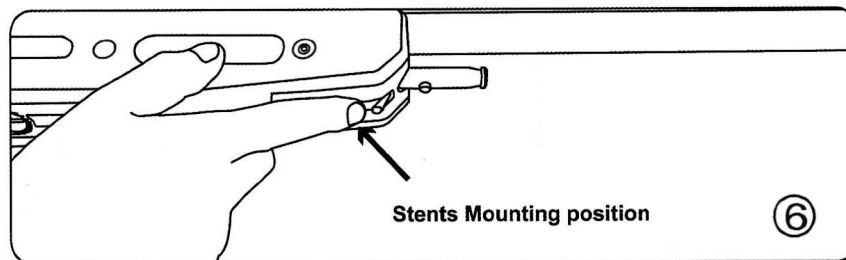
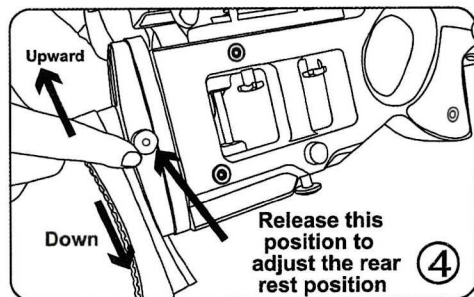
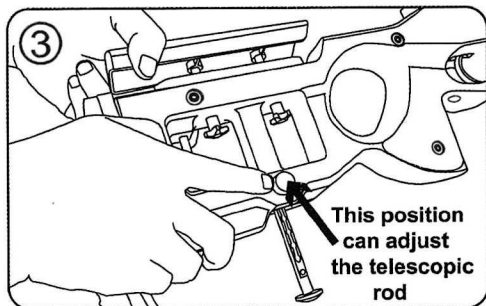
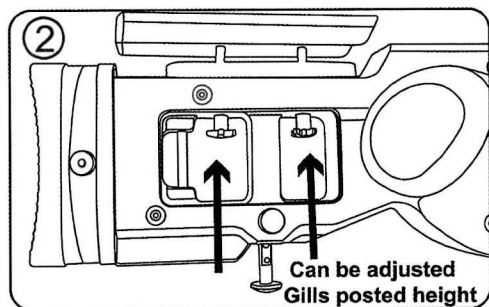
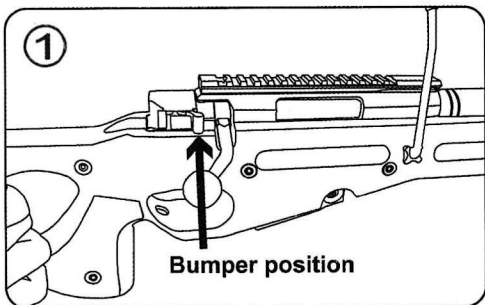
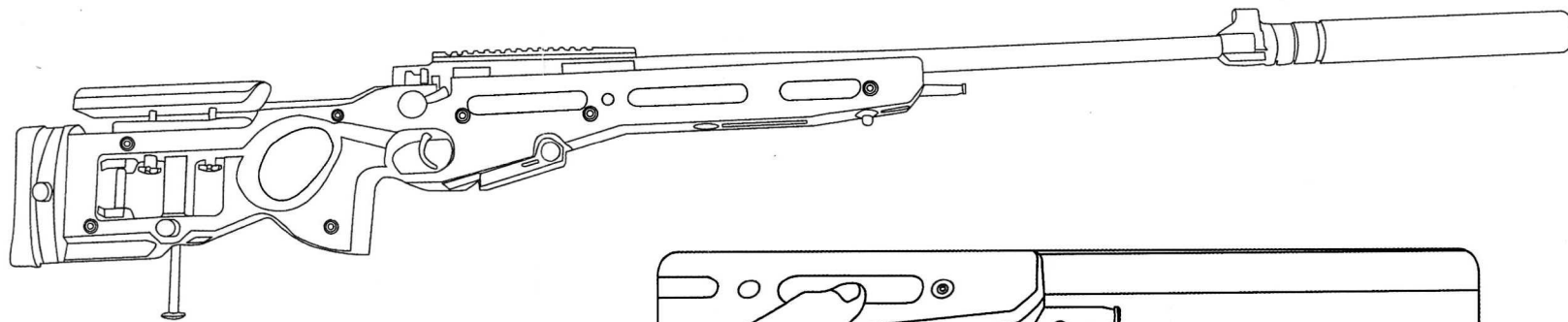

P PRODUCT DECOMPOSITION DIAGRAM

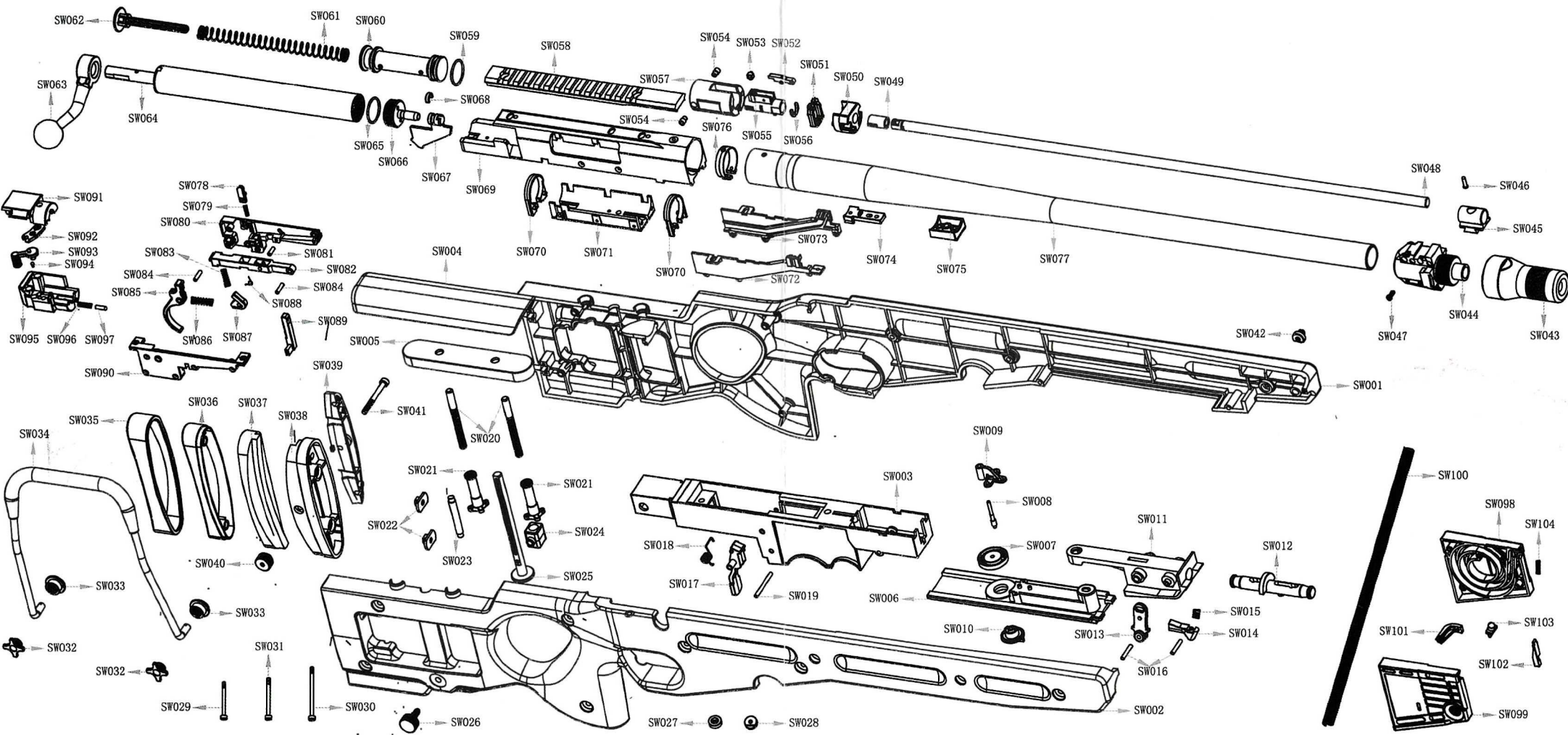

REGULATION

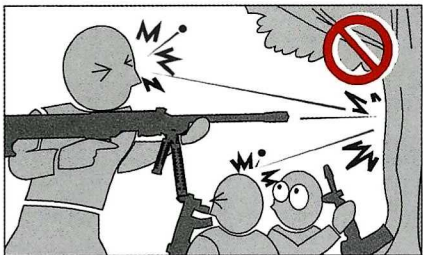

When shooting the Airsoft Gun for a target or game, you and all participants must wear goggles or other eye protective gear, also paying attention to ricochets. (Pay sufficient attention also to third personnel other than participants.)

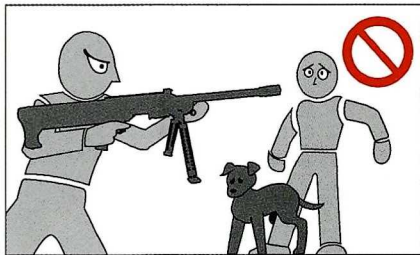

Never aim or shoot a person or animal as the target, Always attach the protective plug to the muzzle, except when you are ready to shoot a target.



Always put the Airsoft Gun in a case or bag when you are carrying it.

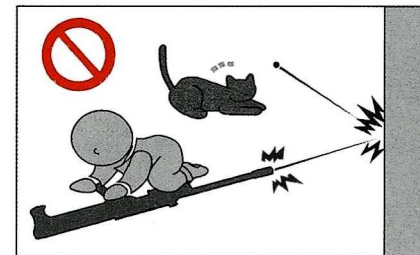

Store the Airsoft Gun at places out of reach by children

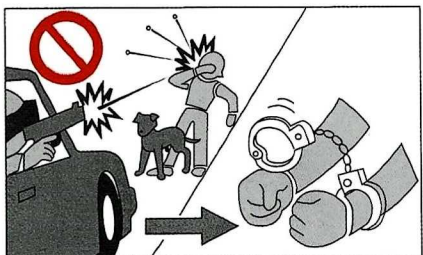

You may be punished if you are shooting for a practical joke.



Avoid pulling the trigger carelessly.

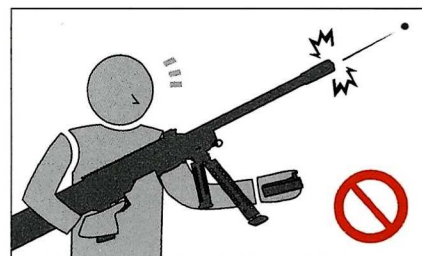

BB bullets may be shot out even if the magazine is removed.

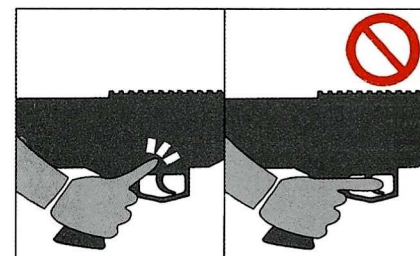

Release and put away your fingers from the trigger, except when you are ready to shoot a target.

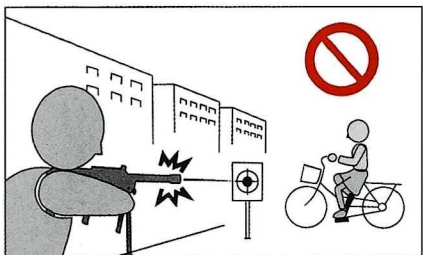

Never shoot the Airsoft Gun at places where people and cars pass cross.

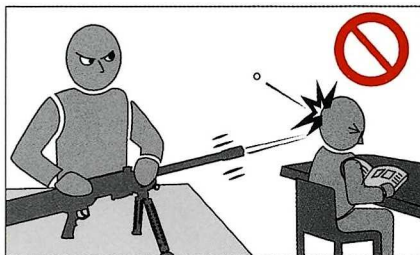

Always direct the muzzle towards a safe direction.

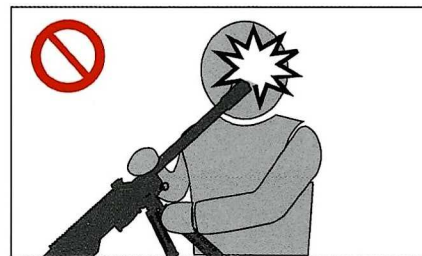

Never look into the gun muzzle.

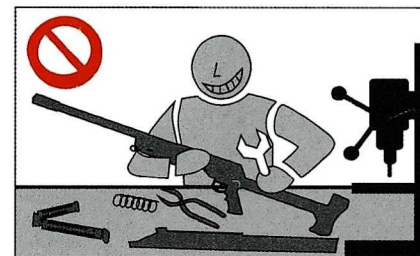

Never disassemble or modify the Airsoft Gun.



Observe warnings and cautions written in your operating manual. OBEY all laws and regulations on proper airgun handling in your area.